



OF CLINTON
HVAC • FABRICATION

Email or Fax the completed form to:

gtpauley@winsupplyinc.com | FAX: 563-242-7467

Questions? Call: 563-242-4994

Order By

Date:

Company: _____

Name: _____ Phone: _____

Notes: _____

FLAT TOP (FT)
FLAT BOTTOM (FB)

ON CENTER (OC)
TOP UP (TU)

TOP DOWN (TD)
BOTTOM UP (BU)

BOTTOM DOWN (BD)

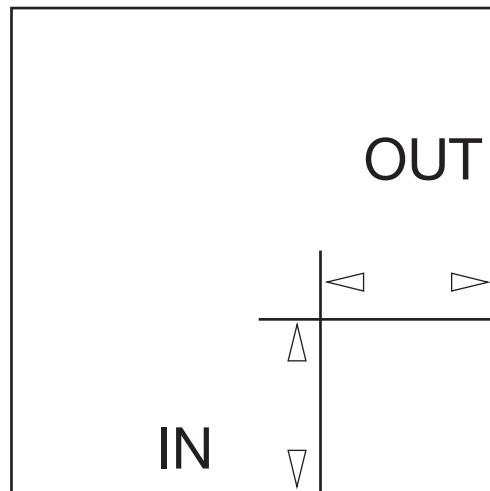
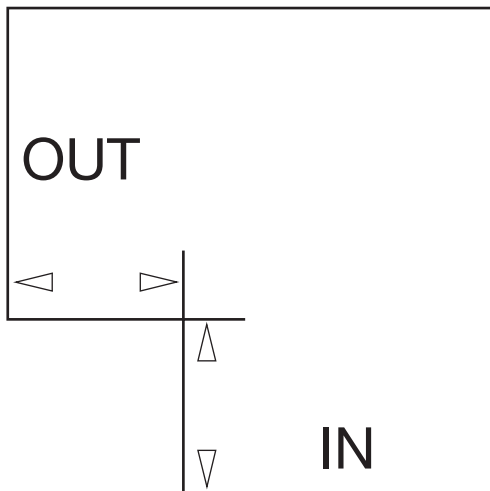
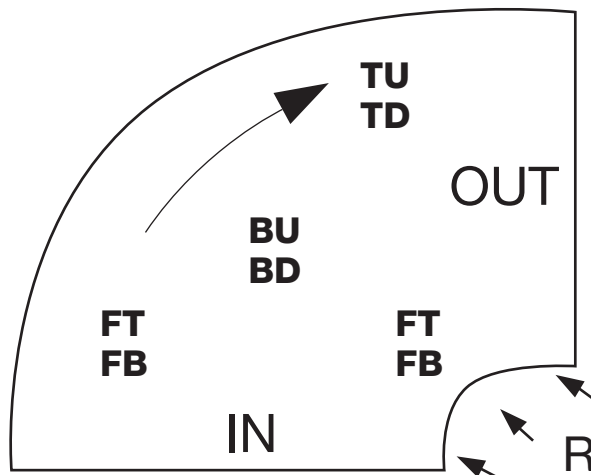
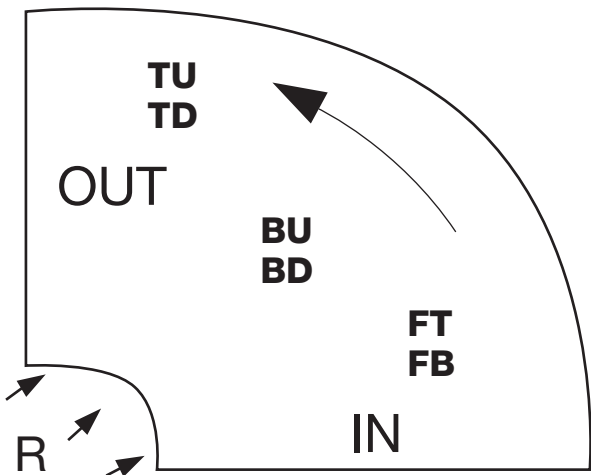

MEASUREMENTS: □ DRIVE TO DRIVE □ RAW TO RAW

ACOUSTIC LINFR: □ 1/2" □ 1" □ 2" FSK INSULATION: □ 1/2" □ 2" □ 3"

FLAT TOP (FT)	ON CENTER (OC)	TOP DOWN (TD)	BOTTOM DOWN (BD)
FLAT BOTTOM (FB)	TOP UP (TU)	BOTTOM UP (BU)	

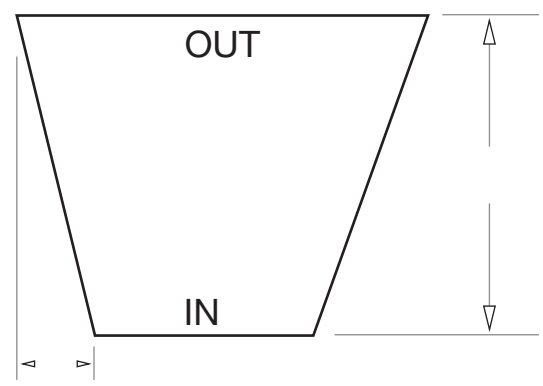
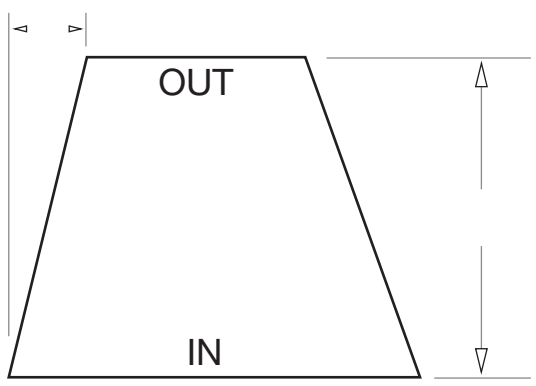
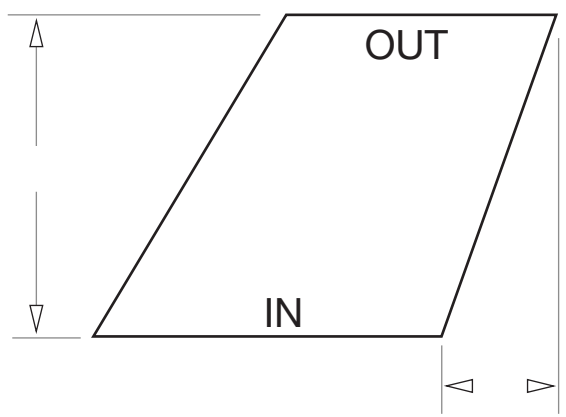
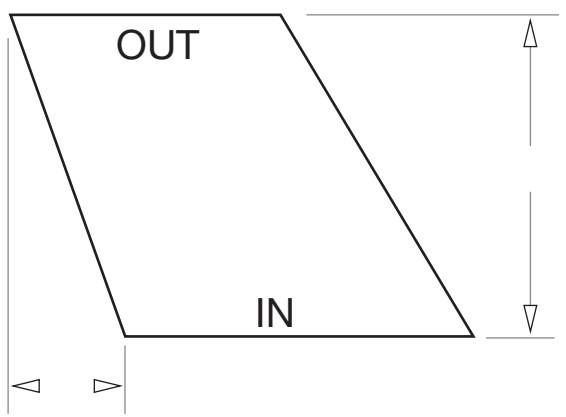
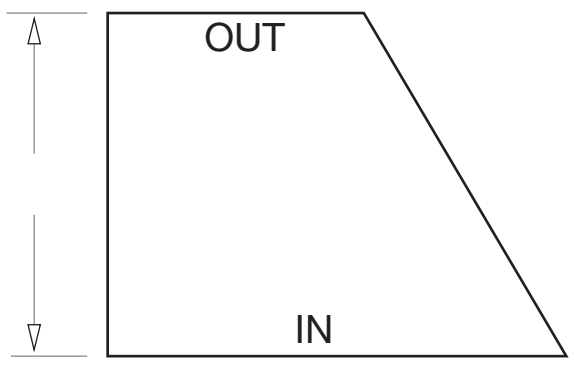
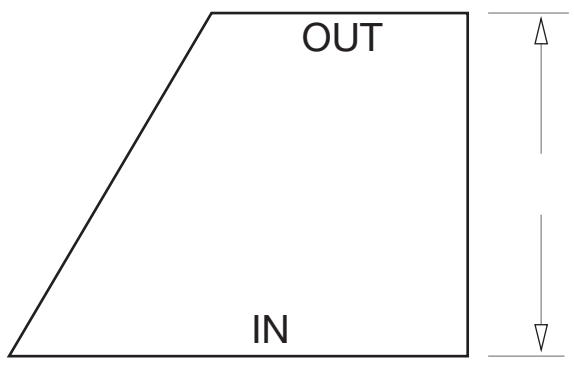

MEASUREMENTS: □ DRIVE TO DRIVE □ RAW TO RAW
ACOUSTIC LINFR: □ 1/2" □ 1" □ 2" FSK INSULATION: □ 1/2" □ 2" □ 3"

FLAT TOP (FT)	ON CENTER (OC)	TOP DOWN (TD)	BOTTOM DOWN (BD)
FLAT BOTTOM (FB)	TOP UP (TU)	BOTTOM UP (BU)	

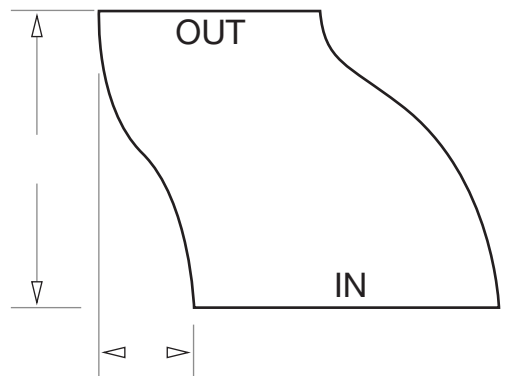
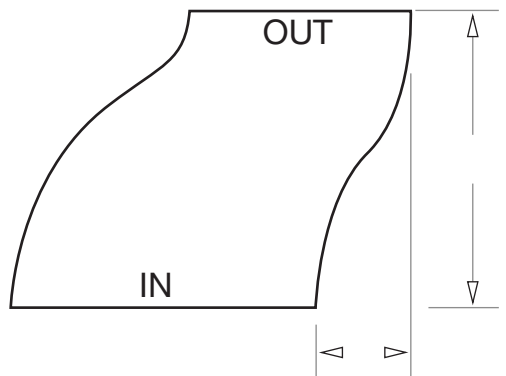
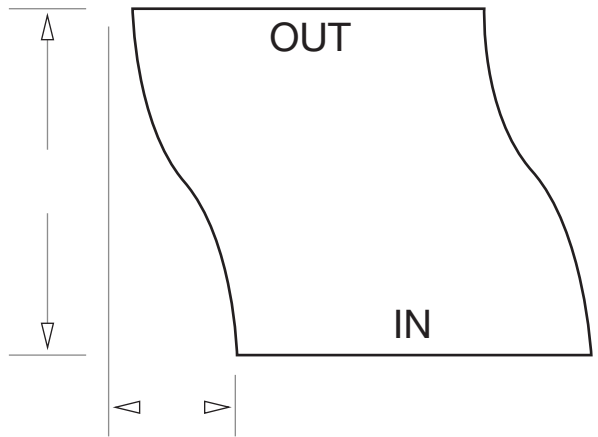
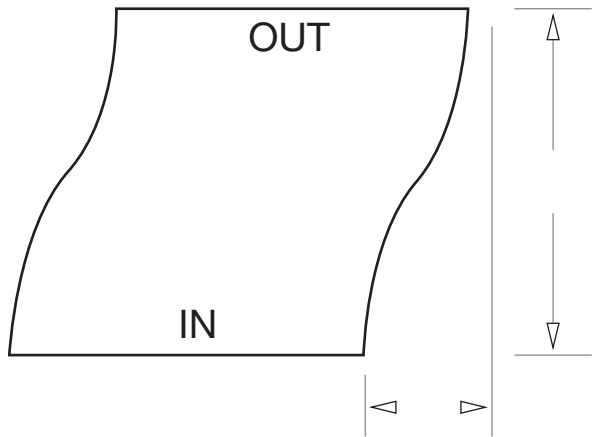
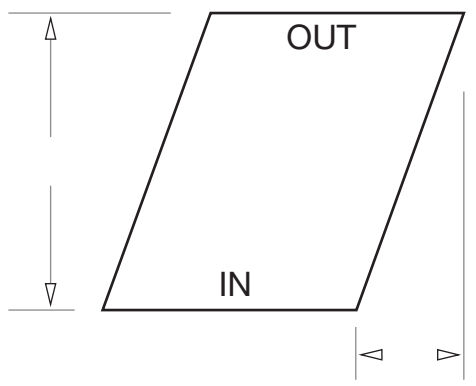
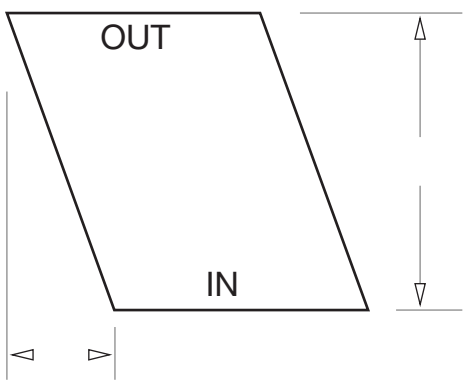

MEASUREMENTS: □ DRIVE TO DRIVE □ RAW TO RAW
ACOUSTIC LINFR: □ 1/2" □ 1" □ 2" FSK INSULATION: □ 1/2" □ 2" □ 3"

FLAT TOP (FT)	ON CENTER (OC)	TOP DOWN (TD)	BOTTOM DOWN (BD)
FLAT BOTTOM (FB)	TOP UP (TU)	BOTTOM UP (BU)	

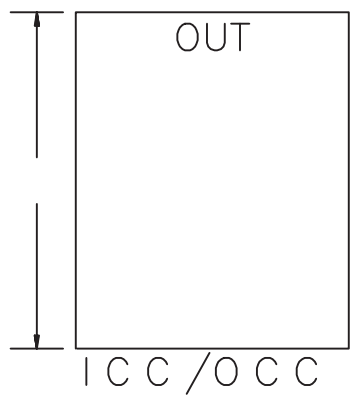
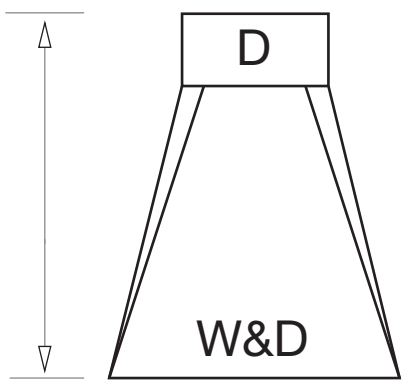
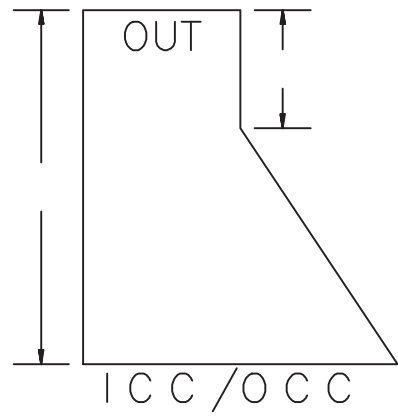
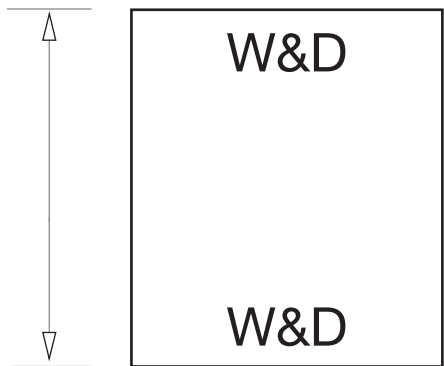
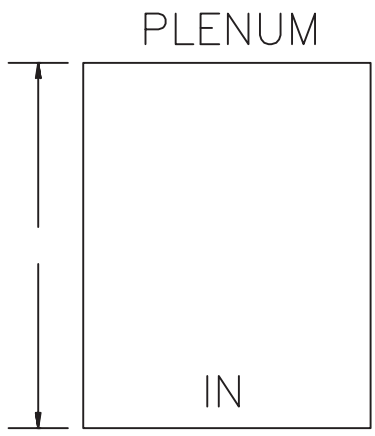
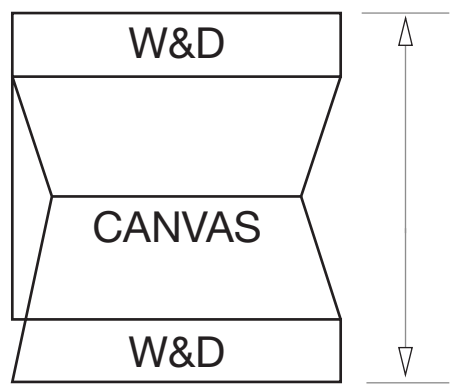

MEASUREMENTS: □ DRIVE TO DRIVE □ RAW TO RAW
ACOUSTIC LINFR: □ 1/2" □ 1" □ 2" FSK INSULATION: □ 1/2" □ 2" □ 3"

FLAT TOP (FT)	ON CENTER (OC)	TOP DOWN (TD)	BOTTOM DOWN (BD)
FLAT BOTTOM (FB)	TOP UP (TU)	BOTTOM UP (BU)	

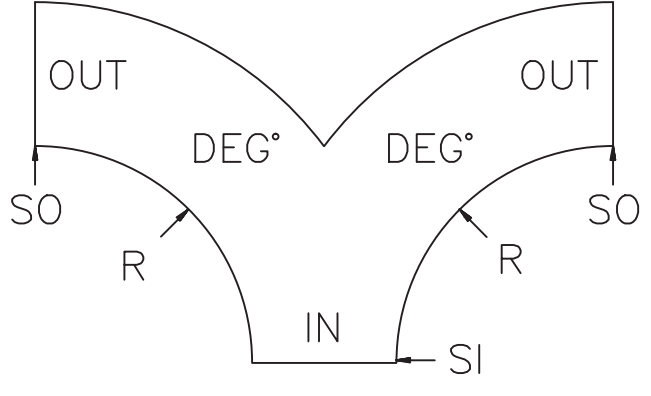
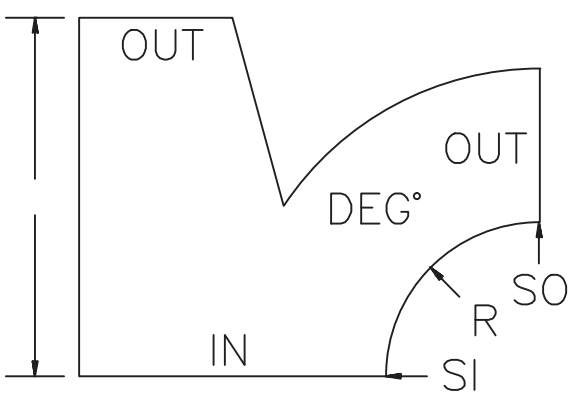
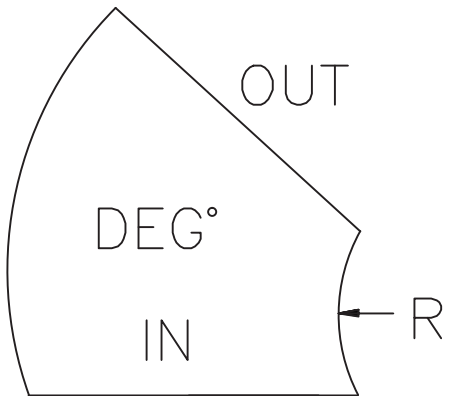
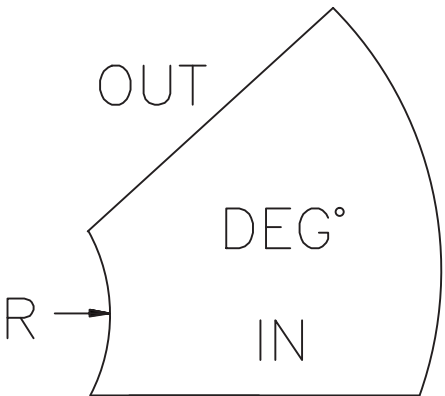
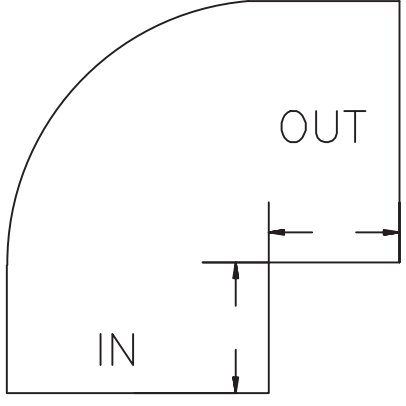
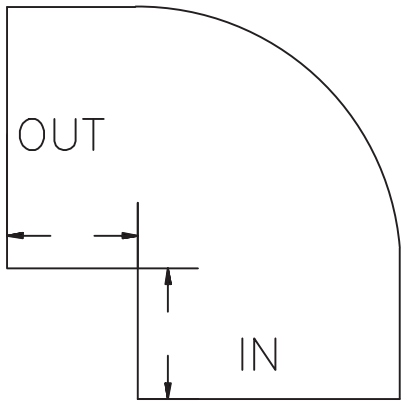

MEASUREMENTS: □ DRIVE TO DRIVE □ RAW TO RAW
ACOUSTIC LINFR: □ 1/2" □ 1" □ 2" FSK INSULATION: □ 1/2" □ 2" □ 3"

FLAT TOP (FT)	ON CENTER (OC)	TOP DOWN (TD)	BOTTOM DOWN (BD)
FLAT BOTTOM (FB)	TOP UP (TU)	BOTTOM UP (BU)	

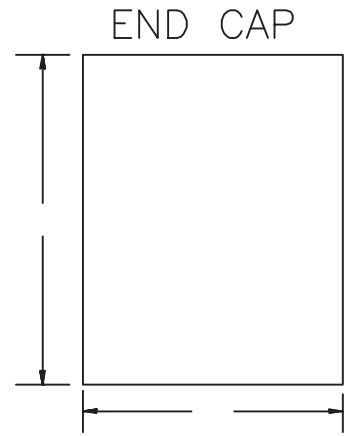
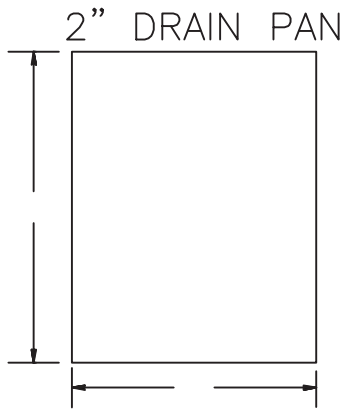
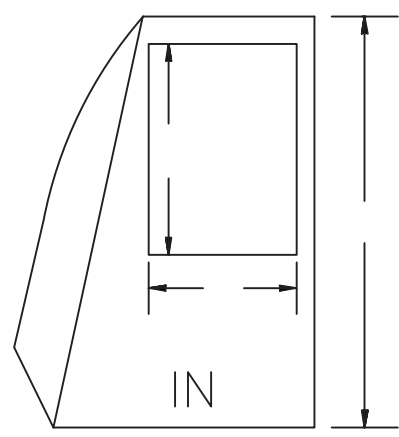
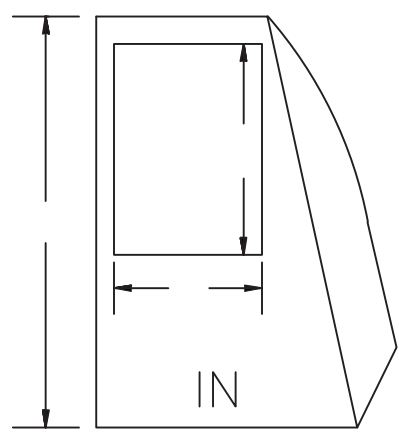
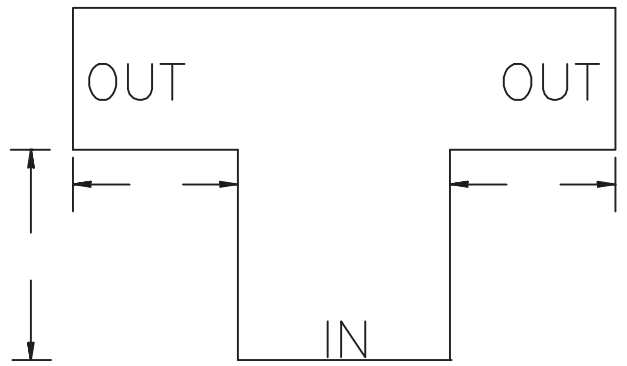
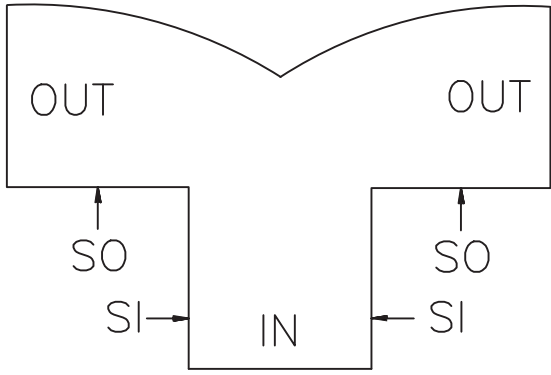

MEASUREMENTS: □ DRIVE TO DRIVE □ RAW TO RAW
ACOUSTIC LINFR: □ 1/2" □ 1" □ 2" FSK INSULATION: □ 1/2" □ 2" □ 3"