

Email the completed form to:
 FabShop@denverwinair.com

Questions? Call: 303-936-2873

Order By	Date: _____
Company: _____	
Name: _____ Phone: _____	
Notes: _____	

FLAT TOP (FT)	ON CENTER (OC)	TOP DOWN (TD)	BOTTOM DOWN (BD)
FLAT BOTTOM (FB)	TOP UP (TU)	BOTTOM UP (BU)	

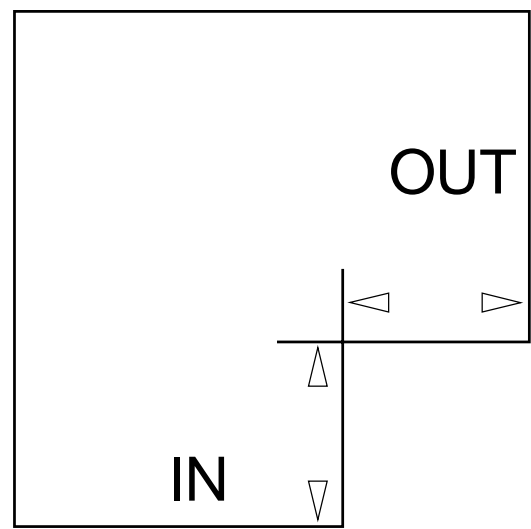
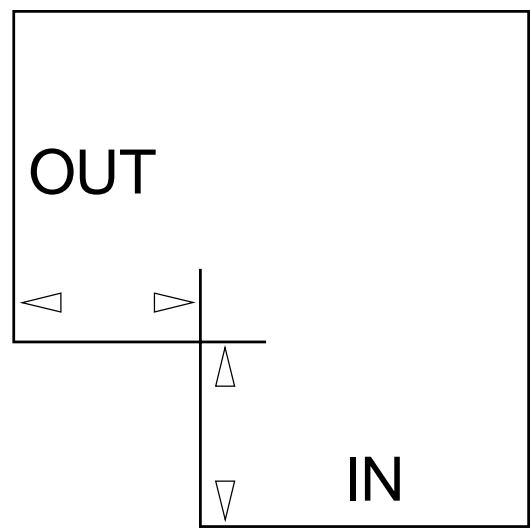
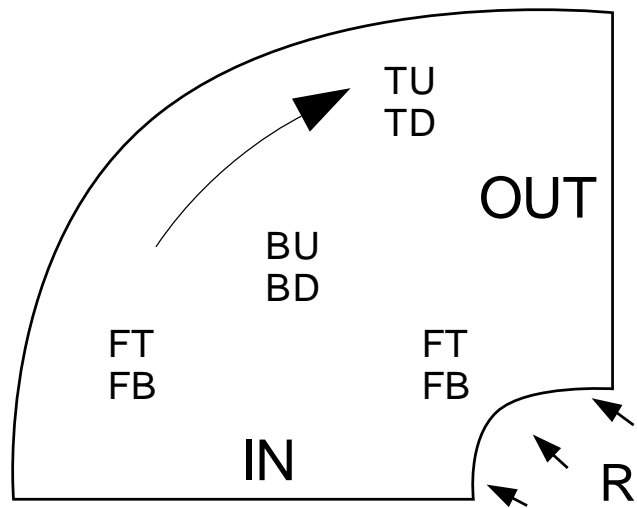
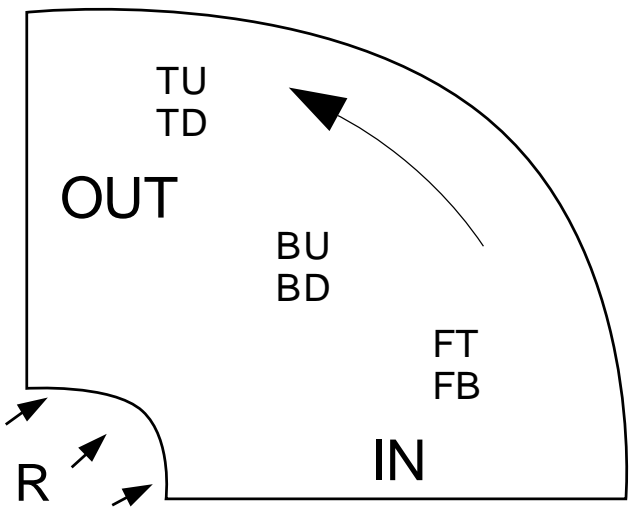

MEASUREMENTS: DRIVE TO DRIVE RAW TO RAW
 ACOUSTIC LINFR: 1/2" 1" 2" FSK INSULATION: 1/2" 2" 3"

FLAT TOP (FT)	ON CENTER (OC)	TOP DOWN (TD)	BOTTOM DOWN (BD)
FLAT BOTTOM (FB)	TOP UP (TU)	BOTTOM UP (BU)	

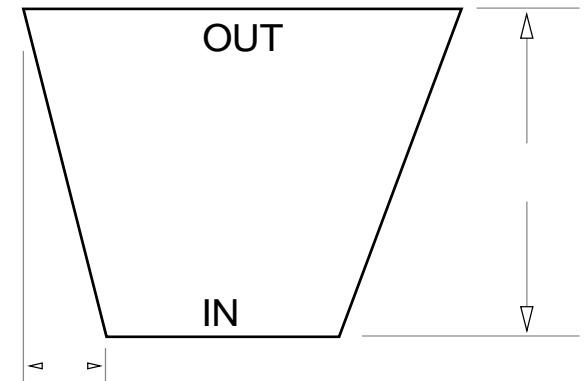
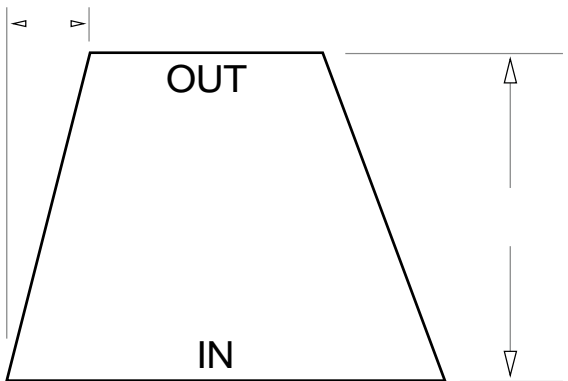
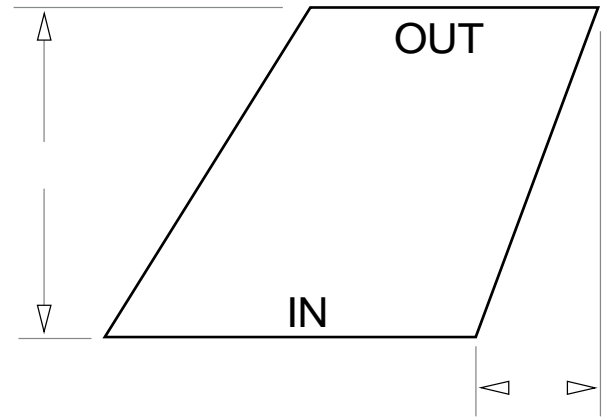
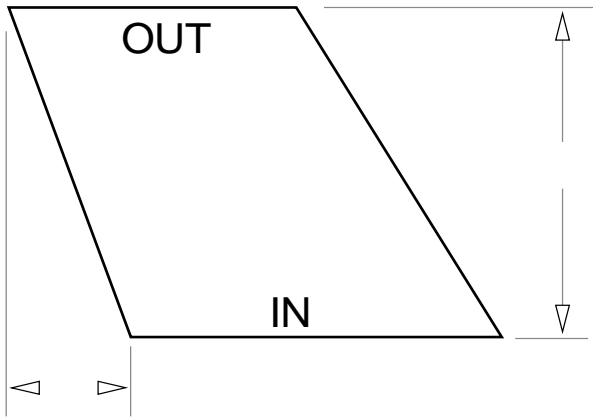
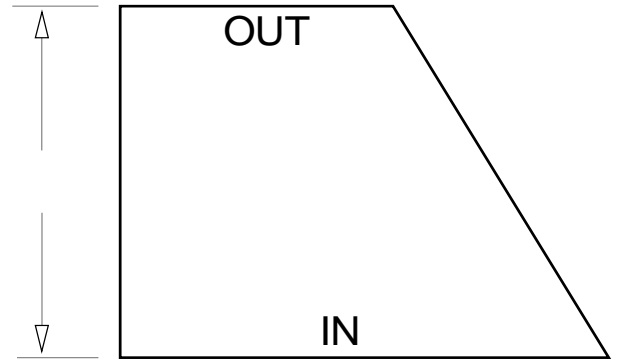
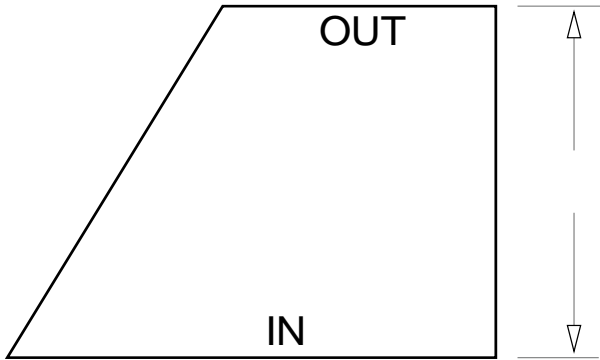

MEASUREMENTS: DRIVE TO DRIVE RAW TO RAW
 ACOUSTIC LINFR: 1/2" 1" 2" FSK INSULATION: 1/2" 2" 3"

FLAT TOP (FT)	ON CENTER (OC)	TOP DOWN (TD)	BOTTOM DOWN (BD)
FLAT BOTTOM (FB)	TOP UP (TU)	BOTTOM UP (BU)	

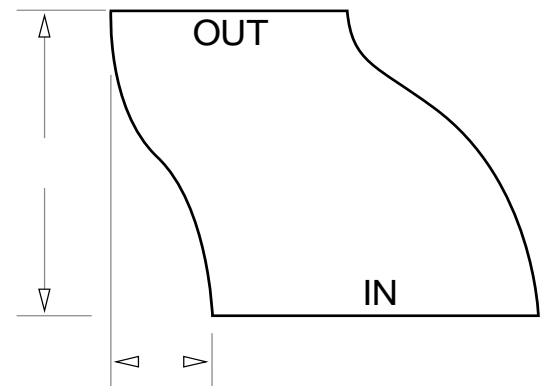
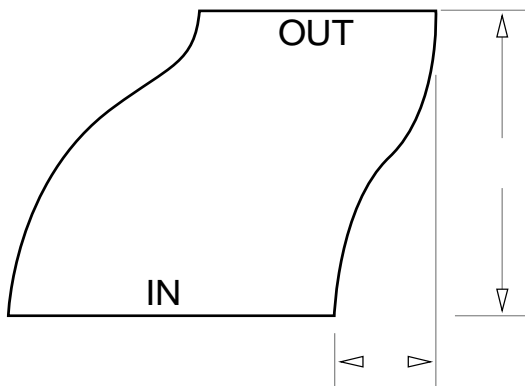
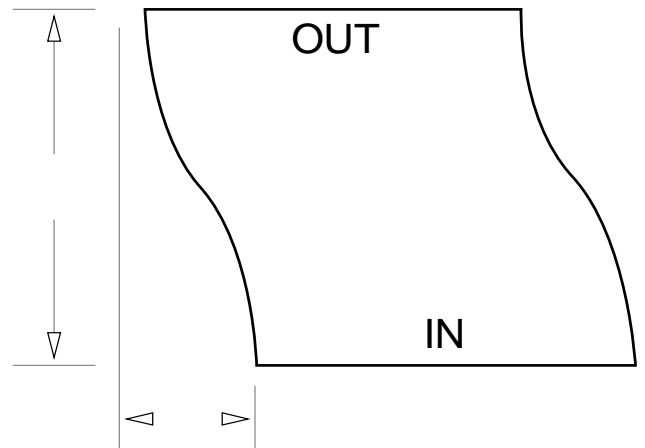
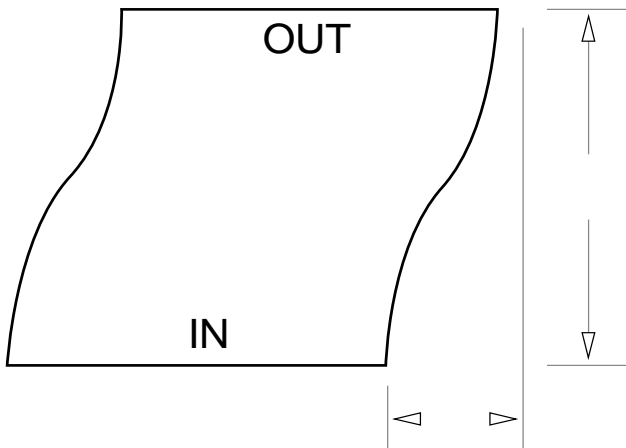
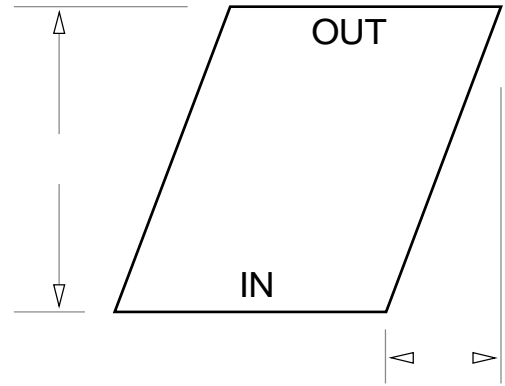
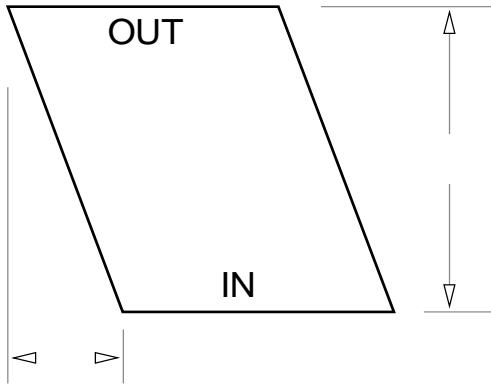

MEASUREMENTS: DRIVE TO DRIVE RAW TO RAW
 ACOUSTIC LINFR: 1/2" 1" 2" FSK INSULATION: 1/2" 2" 3"

FLAT TOP (FT)	ON CENTER (OC)	TOP DOWN (TD)	BOTTOM DOWN (BD)
FLAT BOTTOM (FB)	TOP UP (TU)	BOTTOM UP (BU)	

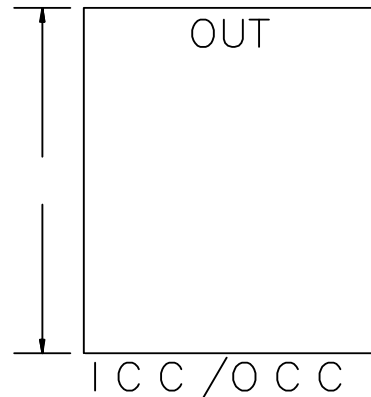
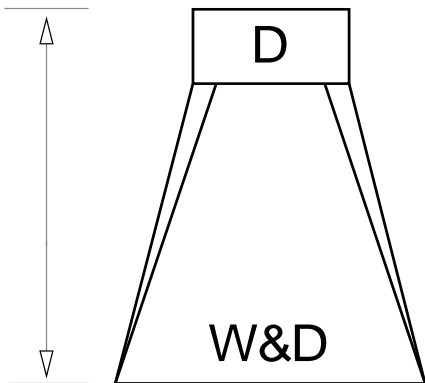
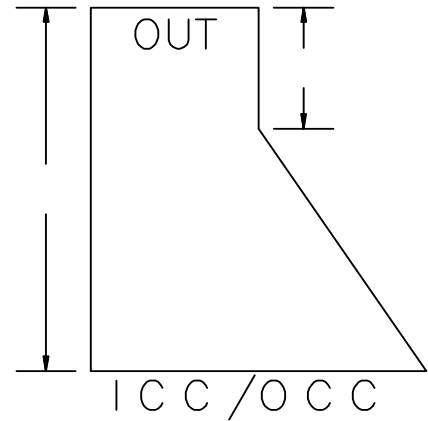
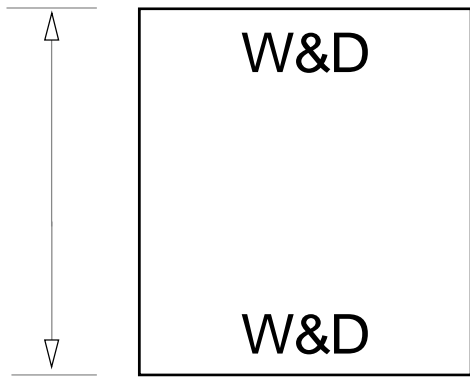
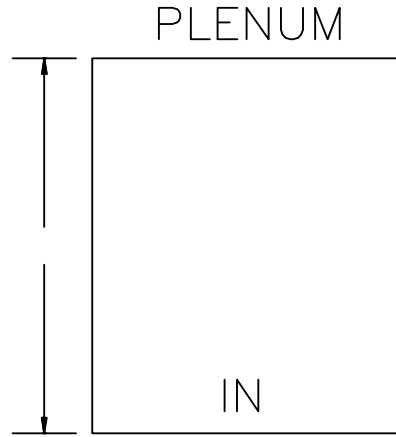
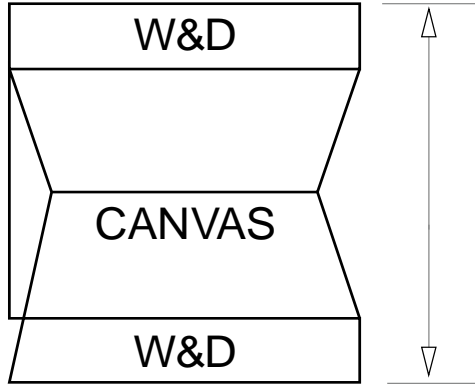

MEASUREMENTS: DRIVE TO DRIVE RAW TO RAW
 ACOUSTIC LINFR: 1/2" 1" 2" FSK INSULATION: 1/2" 2" 3"

FLAT TOP (FT)	ON CENTER (OC)	TOP DOWN (TD)	BOTTOM DOWN (BD)
FLAT BOTTOM (FB)	TOP UP (TU)	BOTTOM UP (BU)	

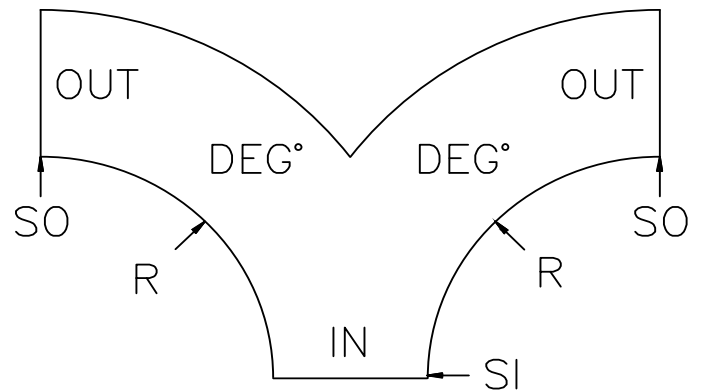
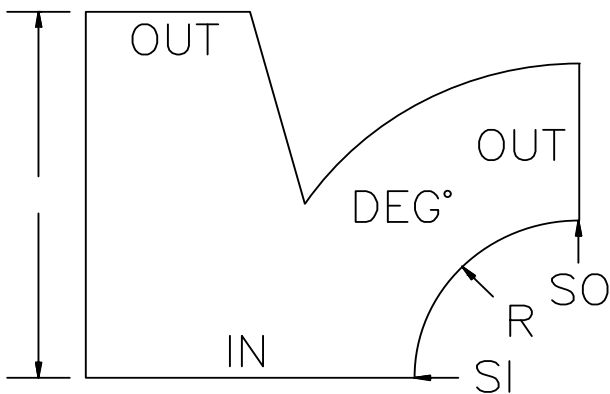
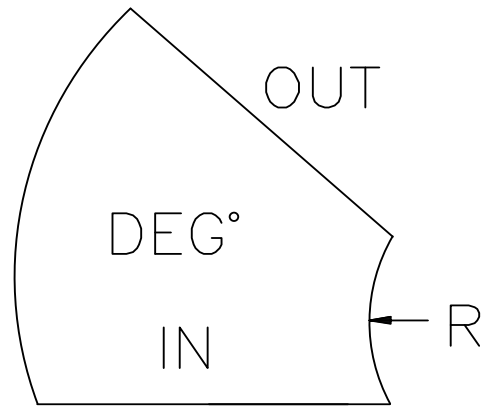
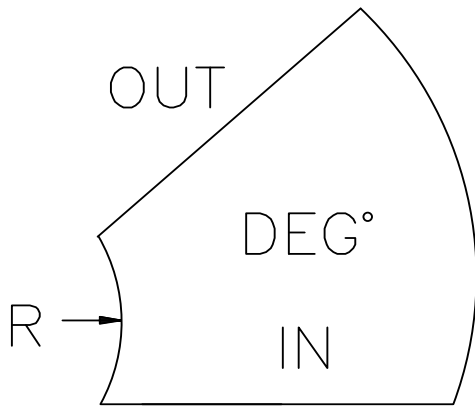
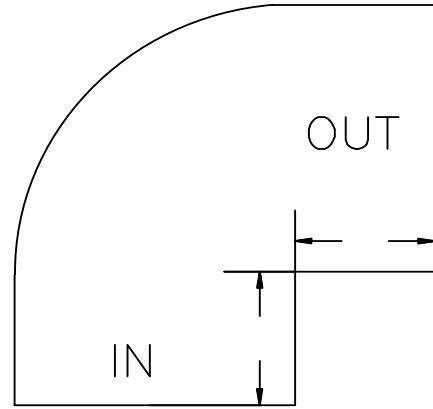
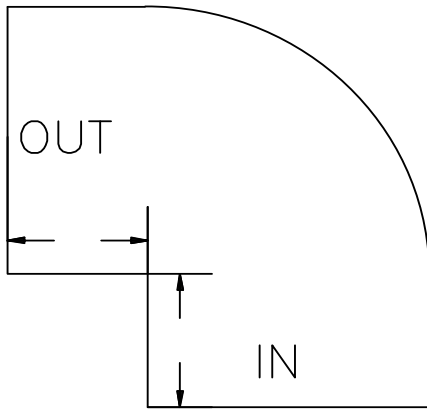

MEASUREMENTS: DRIVE TO DRIVE RAW TO RAW

ACOUSTIC LINFR: 1/2" 1" 2" FSK INSULATION: 1/2" 2" 3"

FLAT TOP (FT)	ON CENTER (OC)	TOP DOWN (TD)	BOTTOM DOWN (BD)
FLAT BOTTOM (FB)	TOP UP (TU)	BOTTOM UP (BU)	

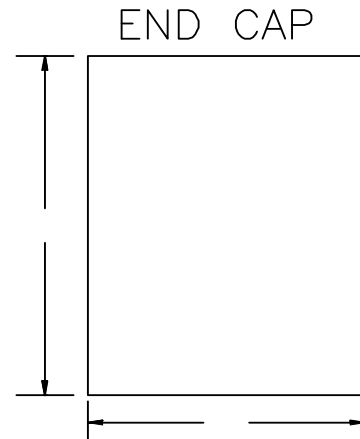
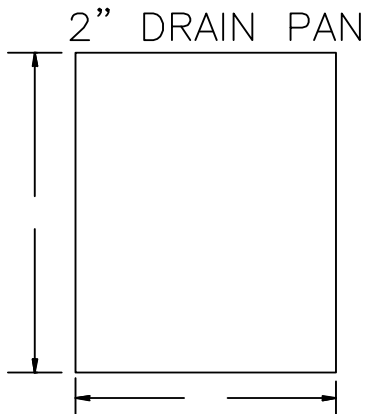
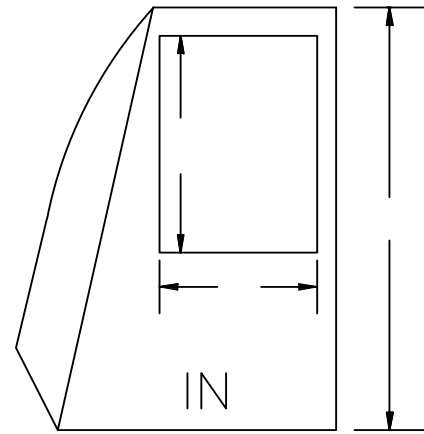
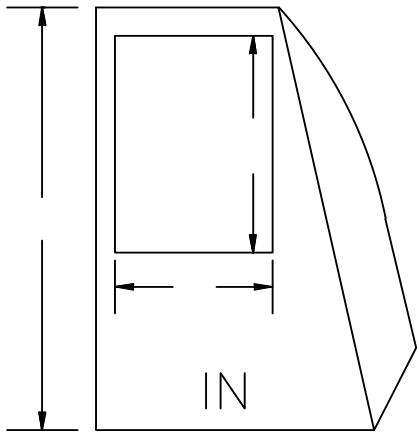
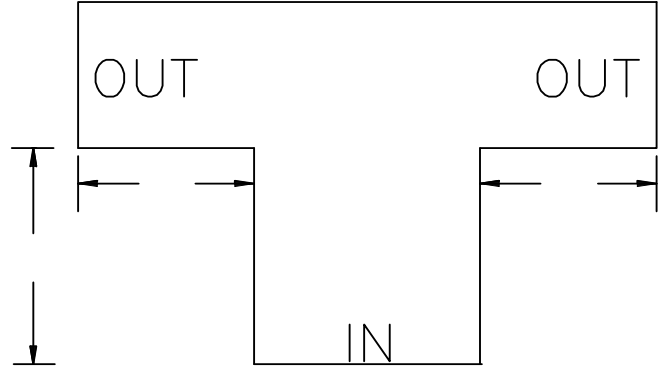
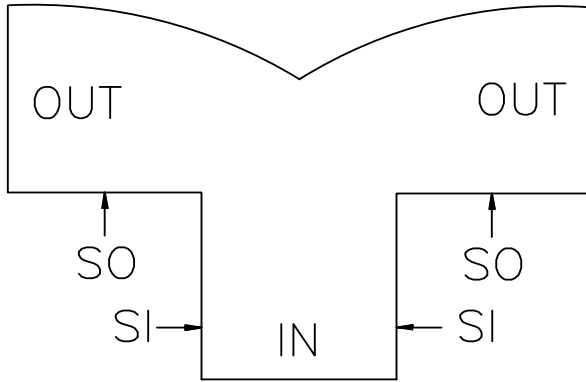

MEASUREMENTS: □ DRIVE TO DRIVE □ RAW TO RAW
 ACOUSTIC LINFR: □ 1/2" □ 1" □ 2" FSK INSULATION: □ 1/2" □ 2" □ 3"